

# GENUINE ALUMINUM FOOTREST KIT

## INSTALLATION AND USER'S INSTRUCTIONS



Thank you for purchasing a genuine Mazda accessory.

Before removal and installation, be sure to thoroughly read these instructions.

Please read the contents of this booklet in order to properly install and use the aluminum footrest kit. Your safety depends on it.

Keep these instructions with your vehicle records for future reference.

### **WARNING**

- There are several  **WARNING** and  **CAUTION** sections in this booklet concerning safety when installing or removing the aluminum footrest kit. Always read and follow them in order to prevent injuries, accidents, and possible damage to the vehicle.

 **WARNING:** Indicates a situation in which serious injury or death could result if the warning is ignored.

 **CAUTION:** Indicates a situation in which bodily injury or damage to the vehicle could result if the caution is ignored.

- For areas indicating the tightening torque in this instruction manual, tighten to the specified torque using a torque wrench. For areas in which the tightening torque is indicated inside parentheses ( ), the tightening torque is indicated as a reference value, however tightening using a torque wrench is not necessary.
- Do not modify the aluminum footrest kit.
- Do not install the aluminum footrest kit in any way other than described in the following instructions.
- If in any doubt, please ask your Mazda dealer to install the accessory in order to prevent errors in installation.
- If you have any questions about the use of the accessory, ask your Mazda dealer for proper advice before using it.
- Mazda and its suppliers are not responsible for injuries, accidents, and damage to persons and property that arise from the failure of the dealer or installer to follow these instructions.
- To ensure safety and reliability of the work, installation, removal and disposal work must be carried out by an Authorized Mazda Dealership.
- Be careful not to lose removed parts, and be sure that they are kept free from scratches, grease or other dirt.

**PART NAME: Aluminum footrest kit**

**PART NUMBER: BHN1 V9 095**

**VEHICLE: MAZDA3, MAZDA6, MAZDA CX-5**

### **NOTE**

#### **To the dealer**

- Please turn over these instructions to the customer after installation.

#### **To the customer**



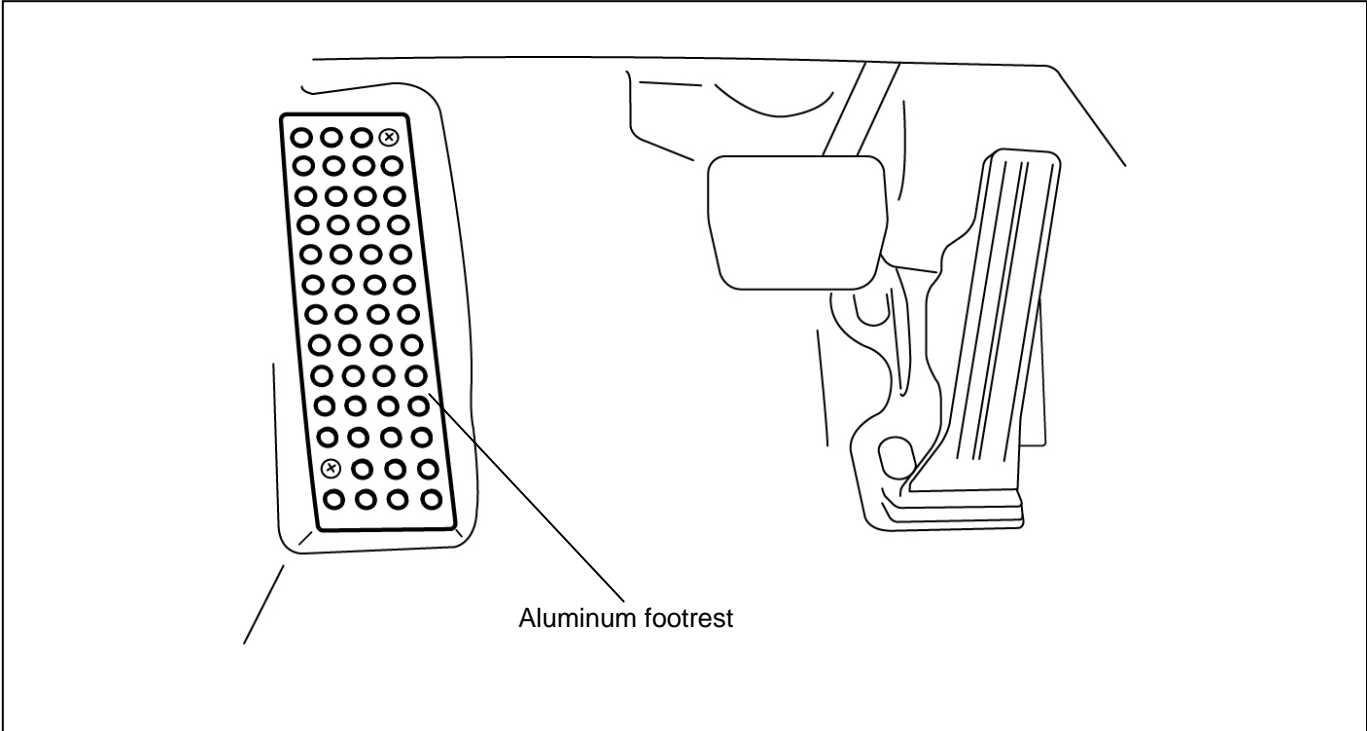

- Keep these instructions after installation. The instructions may be necessary for installing other optional parts or removal of this accessory.
- Should the vehicle or this accessory be resold, always leave these instructions with it for the next owner.

# 1. INSTALLATION VIEW

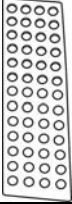

# 2. PARTS

- Before installation, verify that the kit includes all the following parts and that they are free of dirt, scratches, or damage.

Part	Part name	Qty	Part	Part name	Qty
	Aluminum footrest	1		Nut plate	1
	Screw	2		Installation and user's instructions	1

# 3. BEFORE INSTALLATION

## ■ REQUIRED TOOLS

- ☆Screwdriver (Phillips)      ☆Trim removal tool      ☆Torque wrench      ☆Utility knife      ☆Tape
- ☆Soft clean cloth      ☆Electric drill (2.5 mm, 5 mm drill bits)      ☆White marker
- ☆Loctite (Recommendation product: ThreeBond 1303N)

## ⚠ WARNING

Before performing any work, park the vehicle on level ground, apply the parking brake securely, and then block the wheels. If the vehicle moves while performing work, it could cause a serious accident.

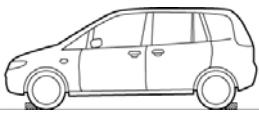

## ⚠ CAUTION

<p>Be sure to cover the vehicle body with protectors or mats to prevent stains, scratches and damage when removing/installing the vehicle parts</p>	<p>Using improper tools may cause damage and or broken parts. Use the correct tool for the job.</p>	<p>Wrap protective tape around screwdrivers and fastener remover tools to prevent scratching the vehicle.</p>	<p>Put the removed parts and the parts in the kit on the protective sheet to prevent scratches.</p>
<p>Be sure to cover the vehicle body with protectors or mats to prevent stains, scratches and damage when removing/installing the vehicle parts</p>	<p>To prevent scratching the vehicle and over-drilling, wrap the drill bit with duct tape.</p>		

## Note

Refer to the Workshop Manual for removal and installation of vehicle parts. Not following the procedures for removal/installation in the Workshop Manual could result in an accident or vehicle malfunction.



## 4. VEHICLE PART REMOVAL

### MAZDA3

#### Front scuff plate removal

1. Grasp the shaded area shown in the figure, detach tab A while pulling the front scuff plate in the direction of the arrow (1) shown in the figure, then detach the hook B, clip, and pin while pulling in the direction of the arrow (2).
2. Grasp the shaded area shown in the figure, detach tab C while pulling the front scuff plate in the direction of the arrow (3) shown in the figure, then detach the hook D, clip, and pin while pulling in the direction of the arrow (4).

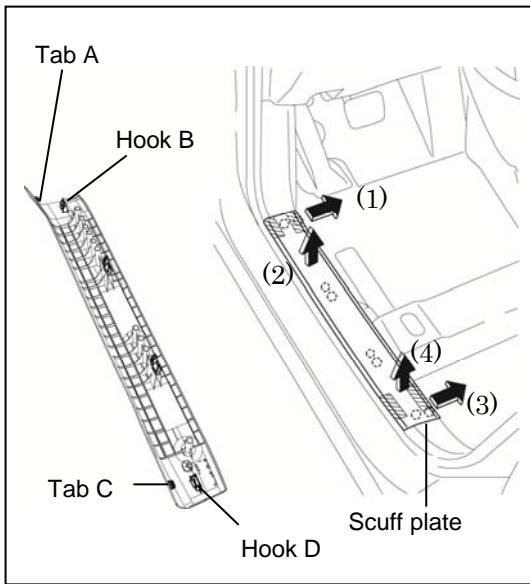

#### Front side trim removal

1. Partially peel back the seaming welt.
2. Remove the cap nut.
3. Pull the front side trim in the direction of the arrow shown in the figure and remove it while detaching the clip.

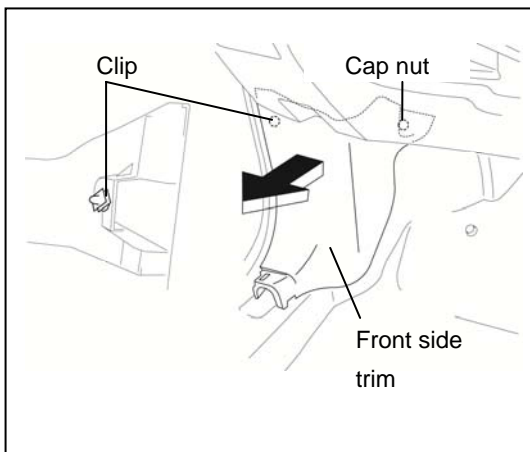

### MAZDA6, MAZDA CX-5

#### Front scuff plate removal

3. Grasp the shaded area shown in the figure, detach tab A while pulling the front scuff plate in the direction of the arrow (1) shown in the figure, then detach the hook B, clip, and pin while pulling in the direction of the arrow (2).
4. Grasp the shaded area shown in the figure, detach tab C while pulling the front scuff plate in the direction of the arrow (3) shown in the figure, then detach the hook D, clip, and pin while pulling in the direction of the arrow (4).

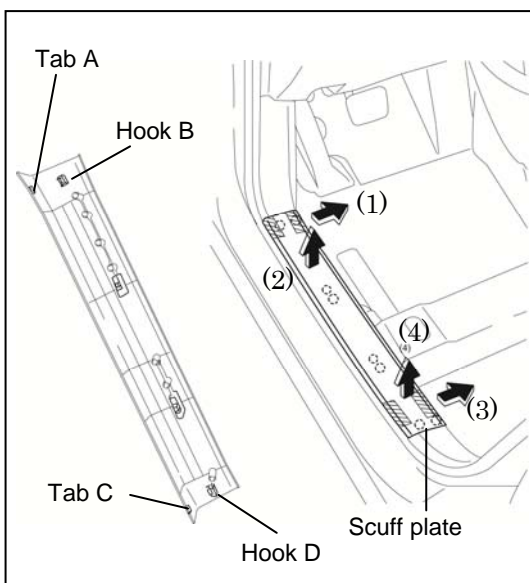

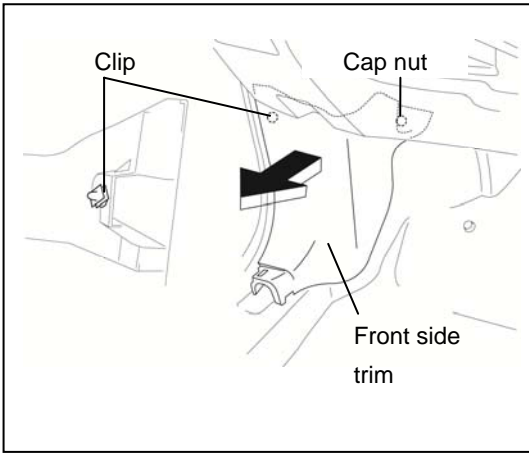

### Front side trim removal

1. Partially peel back the seaming welt.
2. Remove the cap nut.
3. Pull the front side trim in the direction of the arrow shown in the figure and remove it while detaching the clip.

## 5. ALUMINUM PEDAL INSTALLATION

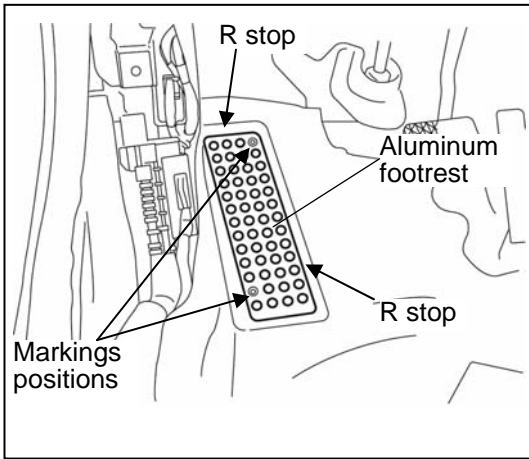

1. Set the aluminum footrest temporarily before installation as shown in the figure. Then mark the mounting hole part by using on the base of R stop of the carpet. (2 point)

2. Create holes in the marked positions (2 locations) using the following procedure for the applicable model.

### MAZDA3, MAZDA CX-5

- Remove the aluminum footrest and then make a hole about diameter 7mm by utility knife at marking position of the carpet.

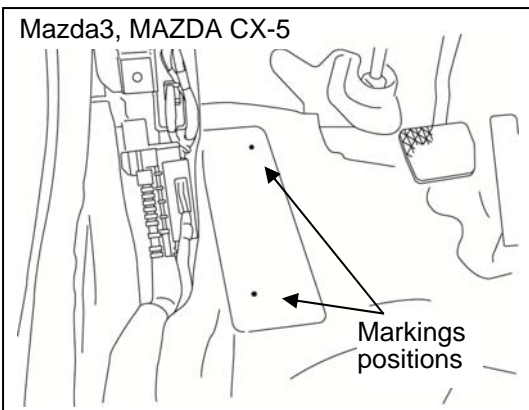

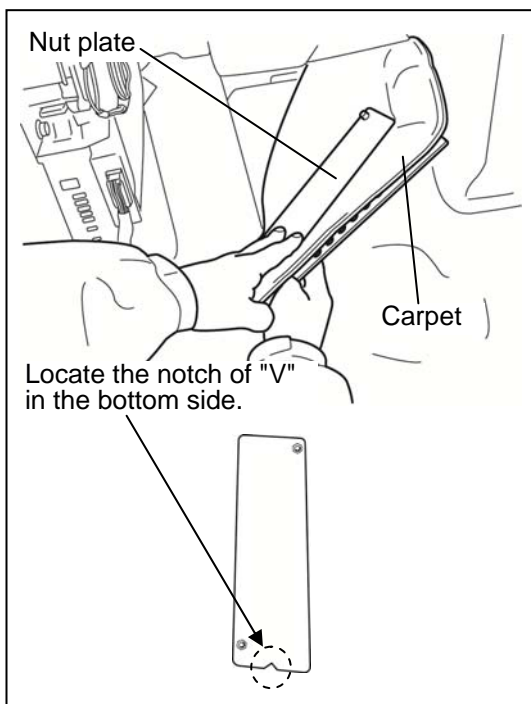
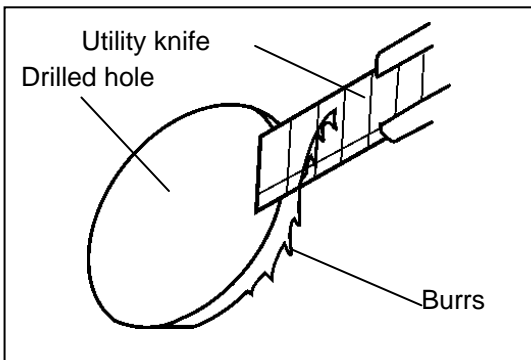
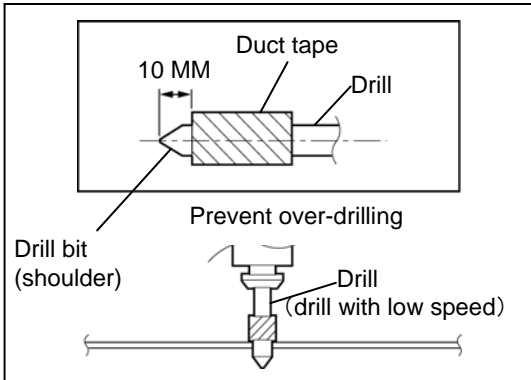
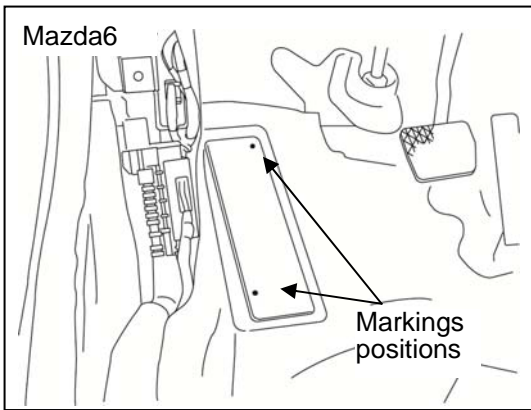

## MAZDA6

- I. Remove the aluminum footrest.
- II. Wrap the drill bit with duct tape as shown in the figure.
- III. Set the drill speed to low.

- Always use a drill with a rotation speed adjustment, otherwise the carpet may deform.
- Be careful when handling drills and other sharp objects.
- To prevent scratching and over-drilling, wrap the drill bit with duct tape.
- When drilling the holes, be careful not to drill too deeply as there is sponge material on the underside.

- IV. With the drill bit pointed perpendicular to the accelerator pedal, drill a hole in the marked position in stages.
- V. Drill hole diameter: From 2.5 mm to 5 mm (1 location).

- VI. Remove any metal burrs around the drilled hole with a utility knife

- Make sure to remove burrs from the surface so that the surface of the footrest is smooth.

- VII. Remove all shavings

- Completely remove drill shavings from the cabin; otherwise they may cause abnormal noise.

3. Peel back the carpet and install the nut plate to the aluminum footrest installation areas on the underside of the carpet. When installing the nut plate, locate the notch of "V" in the bottom side.

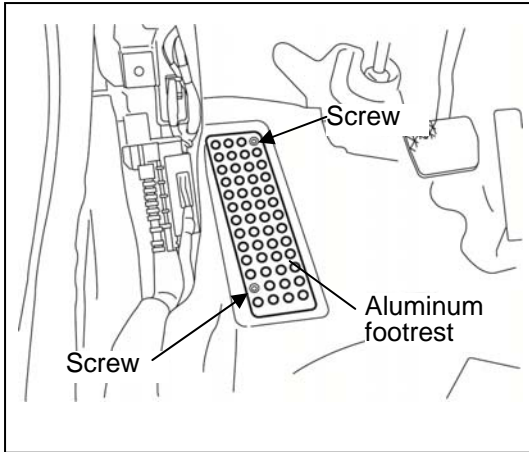

4. Set the aluminum footrest to the footrest.
5. Apply a Loctite at the tip of the screw (2).
6. Install the aluminum footrest using the screw (2).

**Screw tightening torque: 1.0-1.4 Nm**

7. After installing the accelerator footrest. Install the vehicle part in the reverse order of removal.

## **-TO THE CUSTOMER-**

- Please check that there are no slack or vibration of screw. Periodical inspection is required.
- Please be careful of the following points for taking care of this product.
  1. Please do not use hard tools, such as brush when you wash this. It may damage the surface.
  2. Please wash the product with water after using thinned neutral detergent, when it is hard to clean off by washing without soap.

Date _____, _____, _____				
VIN _____				
Approved		Checked		Person in charge

<b>INSTALLATION INSPECTION SHEET</b>	<b>MAZDA3 MAZDA6 MAZDA CX-5</b>	Aluminum footrest kit
		BHN1 V9 095

Perform the following inspections

**1. Inspection items after installation**

Check

- Verify the fitting between the vehicle part and the installed part, and inspect for damage or dirt.

**2. Installation of accessory, operation check**

Inspected part	Inspection item	Inspection	Check
Aluminum footrest	Looseness	Inspect the installation area for looseness.	

The term of validity for this sheet: 3 year